



PVC-500 FOOD PROCESSOR

- › Designed for slicing, grating and shredding on all types of vegetables, fruits and cheese
- › Machine shuts off if cover is opened
- › Cover is completely removable allowing for easy cleaning and changing of discs
- › Comes with 5 blades
- › Easy to operate
- › Durable design
- › Anodized aluminum
- › High power motor
- › No volt safety release

5 blades included

Additional blades available

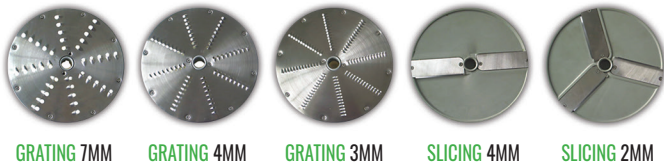

 514-737-9701
  786-600-4687
 TOLL FREE: 888-275-4538
 TOLL FREE: 844-218-8477

5659 ROYALMOUNT AVE, MONTREAL, QC, CANADA H4P2P9
 12000 BISCAYNE BLVD, SUITE #108, MIAMI, FL, USA 33181
 MVPGROUPCORP.COM ✉ SALES@MVPGROUPCORP.COM

PROJECT NAME: _____

LOCATION: _____

ITEM: _____ QTY: _____

MODEL: _____



MODEL	PVC-500
POWER	0.75 HP / 0.56 kW
AMPERAGE	5
WATTS	550
ELECTRICAL	110V/60/1
DISC SPEED	270 RPM
HOPPER OPENING	5.11" x 2.16"
WEIGHT (NET/GROSS)	50.6 lbs / 55 lbs
DIMENSIONS (DxWxH)	19" x 9" x 19.70"
PACKAGING DIMENSIONS	22" x 12" x 23"



Intertek



Intertek



NEMA-5-15P



Warranty: One year parts & labor, carry in exclusive of wear items

Specifications subject to change without notice

*PRIMO is a registered trademark of MVP Group Corp.







Printed May 2018



PVC-500 FOOD PROCESSOR



Accessories – Sold Separately *All blades need to work with an ejector disc

DICING	GRID CUT	SLICING	JULIENNE	SLICING	SLICING
					
D20 20x20x10mm	T10 10x10mm	H10 10x10mm	HU10 10x10mm	H-14 14mm	E5 5mm
D12 12x12x10mm	T8 8x8mm	H8 8x8mm	HU8 8x8mm		E2 2mm
D10 10x10x10mm	T6 6x8mm		HU4 4x4mm		E1 1mm
D8 8x8x8mm	*Needs to work with a slicing blade		HU2.5 2.5x2.5mm		

*Needs to work
with a slicing
blade

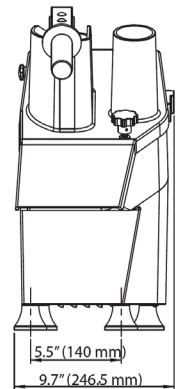
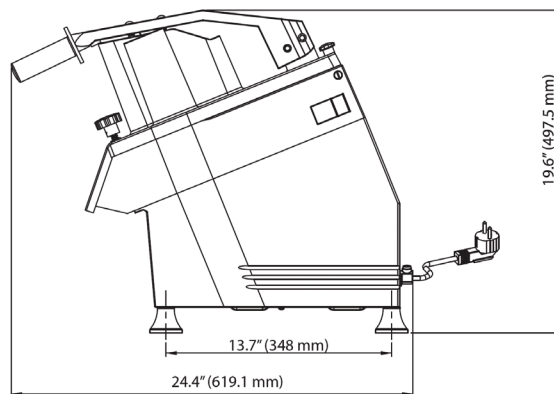
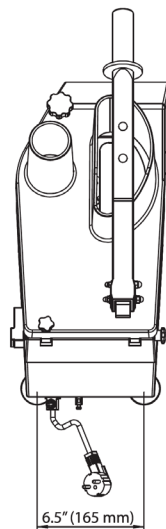

 514-737-9701
  786-600-4687
 TOLL FREE: 888-275-4538
 TOLL FREE: 844-218-8477

5659 ROYALMOUNT AVE, MONTREAL, QC, CANADA H4P2P9
 12000 BISCAYNE BLVD, SUITE #108, MIAMI, FL, USA 33181
 MVPGROUPCORP.COM SALES@MVPGROUPCORP.COM

Warranty: One year parts & labor, carry in exclusive of wear items

Specifications subject to change without notice

*PRIMO is a registered trademark of MVP Group Corp.

Printed May 2018